



DS-TN01-01

VALVOLE TERMOSTATICHE E TERMOSTATIZZABILI CON PREREGOLAZIONE

*Thermostatic and manual radiator valves convertible to
thermostatic with pre-setting*

Serie Tondera

Valvole per l'intercettazione dei fluidi che integrano un dispositivo per la prerogolazione dell'impianto. Sono progettate per l'utilizzo tramite comandi termostatici semplicemente sostituendo la manopola con il comando. La valvola, abbinata al comando termostatico, consente di mantenere costante la temperatura dell'ambiente ove installata riducendo i consumi.

Radiator valves for the interception of fluids in heating systems, equipped with a device for the pre-setting. They are designed to be used combined to a control head, by simply replacing the handwheel with a thermostatic head. The valve, combined with the control head, allows to maintain the temperature of the room, where it is installed, at the set value, providing energy savings.

ART. 0633 0635 0478
0479 0634 0641 0642

Valvole termostatiche attacco per tubo rame e multistrato
Thermostatic radiator valves, connection for copper and multilayer tubes

ART. 0640 0632 0469
0477 0631 0665 0666

Valvole termostatiche attacco per tubo ferro
Thermostatic radiator valves, iron tube connection

ART. 0613 0615 0618
0619 0614 0636 0637

Valvole termostattizzabili attacco per tubo rame e multistrato
Manual radiator valves convertible to thermostatic, connection for copper and multilayer tubes

ART. 0610 0612 0616
0617 0611 0661 0662

Valvole termostattizzabili attacco per tubo ferro
Manual radiator valves convertible to thermostatic, iron tube connection



Valvole a squadra
Angled radiator valves



Valvole via diritta
Straight radiator valves



Valvole reverse
Reverse radiator valves



Valvole attacco verticale
destra e sinistra
*Double angled radiator valves
right and left*



Valvole attacco verticale
destra e sinistra per radiatori misti
*Double angled radiator valves
right and left for mixed radiators*



Teste termostatiche
Thermostatic heads



PRESTAZIONI

Fluidi d'impiego	Acqua, soluzioni glicolate
Percentuale di glicole max	30%
Max pressione d'esercizio	10 bar
Max Temp. d'esercizio	100°C
Minima temperatura impostabile	❄ = 7°C

MATERIALI E CARATTERISTICHE TECNICHE

Corpo	Ottone stampato: CW617N UNI EN 12165
Calotta	
Componenti interni	Ottone trafilato: CW614N UNI EN 12164
Volantino	
Cappuccio termostatico	ABS
Elementi di tenuta	Gomma EPDM PEROX

PERFORMANCE

Employed fluids	Water, antifreeze solutions
Max. percentage of glycol	30%
Max working pressure	10 bar
Max working temperature	100°C
Min. settable temperature	❄ = 7°C

MATERIALS AND TECHNICAL FEATURES

Body	Pressed brass: CW617N UNI EN 12165
Nut	
Inside components	Extruded brass: CW614N UNI EN 12164
Handwheel	
Thermostatic cap	ABS
Seal elements	EPDM PEROX rubber

**SCALA DI REGOLAZIONE TESTE TERMOSTATICHE:
N095, N094, N093, 0090, 0091.**

**ADJUSTMENT SCALE OF THERMOSTATIC HEADS:
N095, N094, N093, 0090, 0091.**



Prerogazione Pre-setting

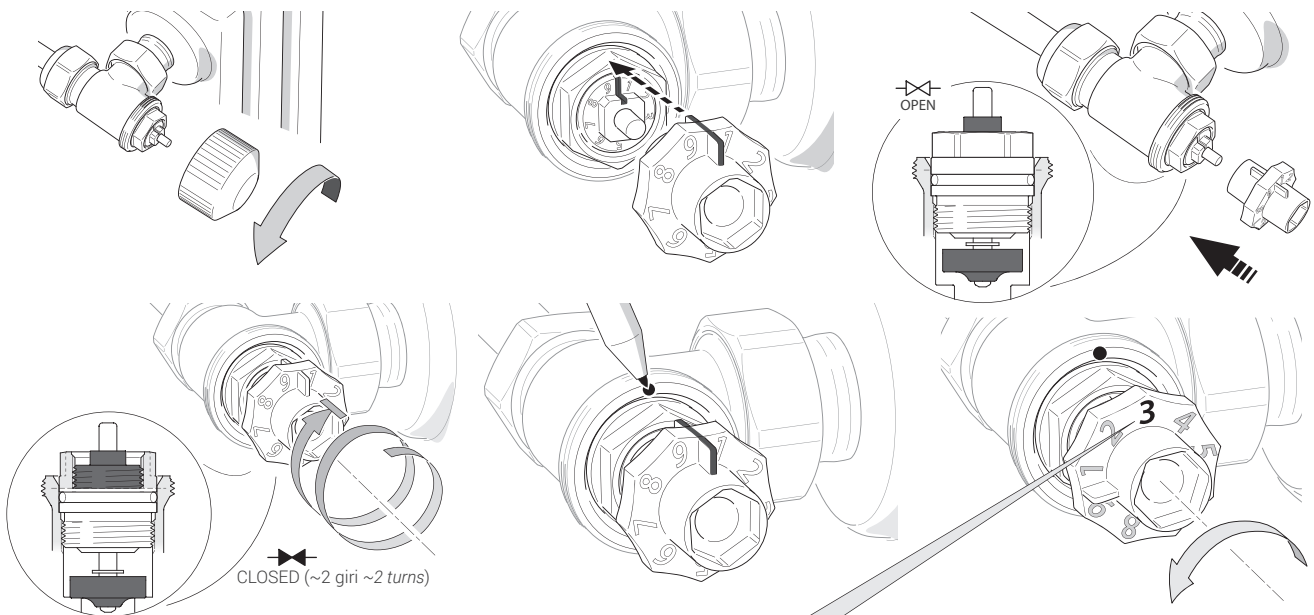

	Posizione Position	1	2	3	4	5	6	7	8	MAX
qmN con banda prop 2K qmN with proportional band 2k [l/h]		0	10,3	83,3	193,3	267	267	267	267	267
(Δp [bar] = 0,1)	qmN Max [l/h]	0	17,7	98,7	211,3	367,2	471,7	529,3	548,5	838

Manutenzione *Maintenance*

Possibilità di sostituzione delle tenute senza svuotare l'impianto (nel caso di perdite dell'asta).

Possibility to replace seals without draining the system (in case of leakage of the valve stem).

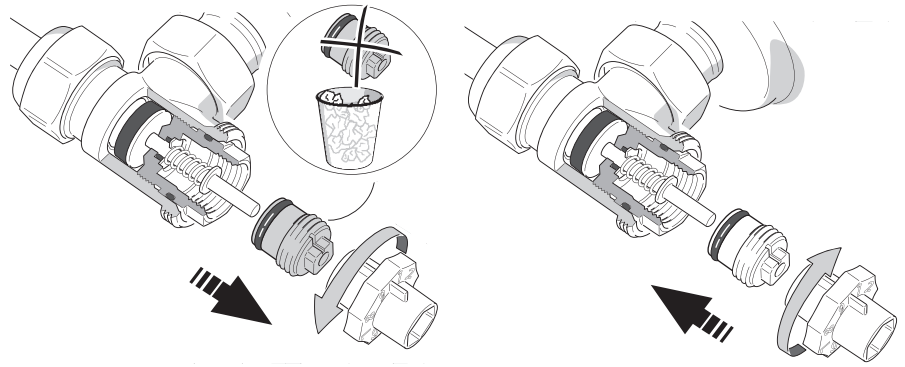

Diagrammi *Diagrams*

Valvole termostatiche con preregolazione, banda proporzionale 2K
Thermostatic radiator valves with pre-setting, proportional band 2k.

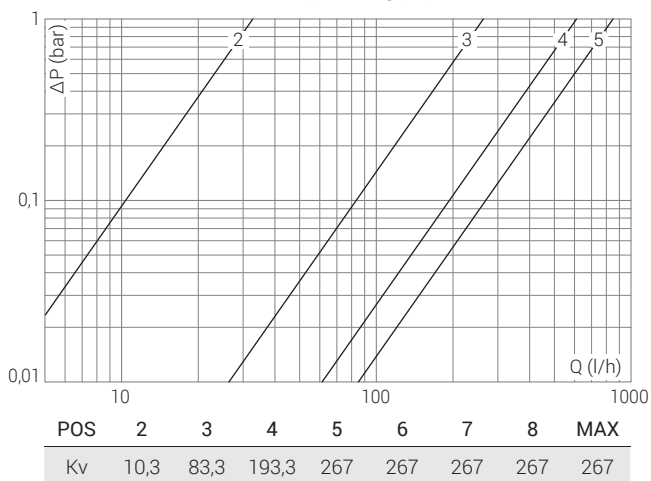

Valvole termostatiche con preregolazione, comando manuale
Thermostatic radiator valves with pre-setting, manual control.

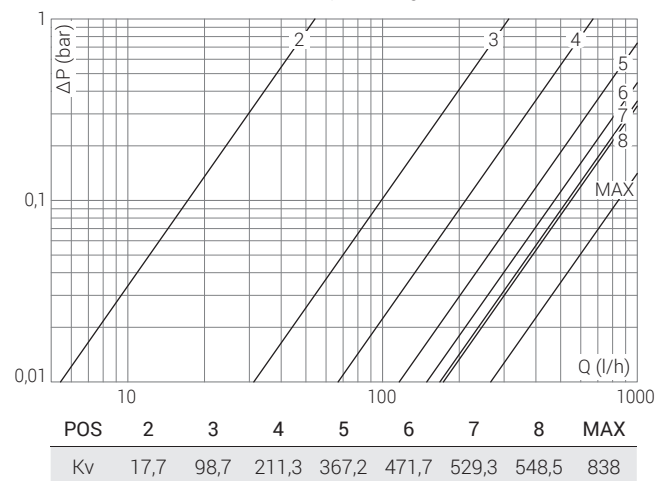

Istruzioni *Instructions*

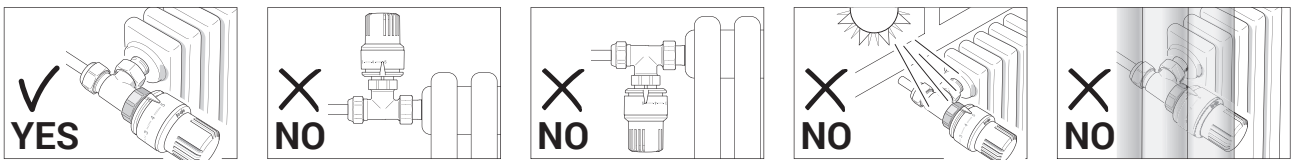

Canapa - PTFE (Teflon)
Hemp - PTFE (Teflon)

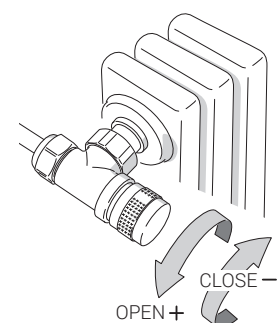
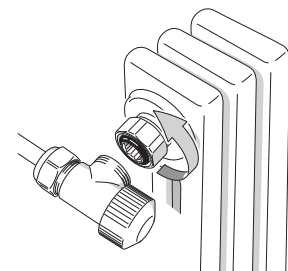
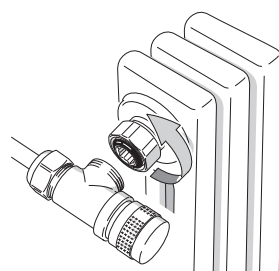
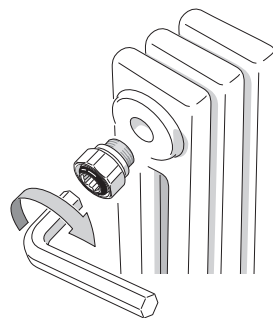
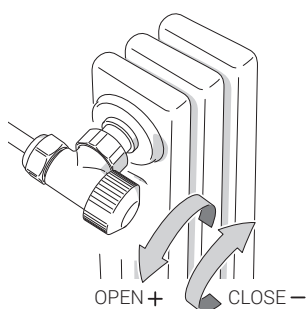
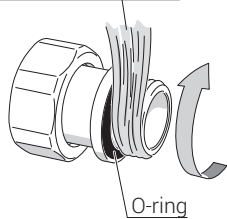

Installazione raccordi *Connection installation*

Art. 0481 - E481

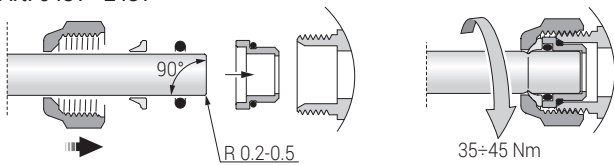

Art. 0483 - E483

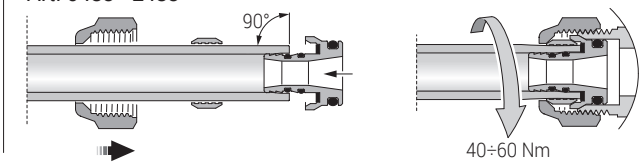

Art. N093 - Installazione *Installation*

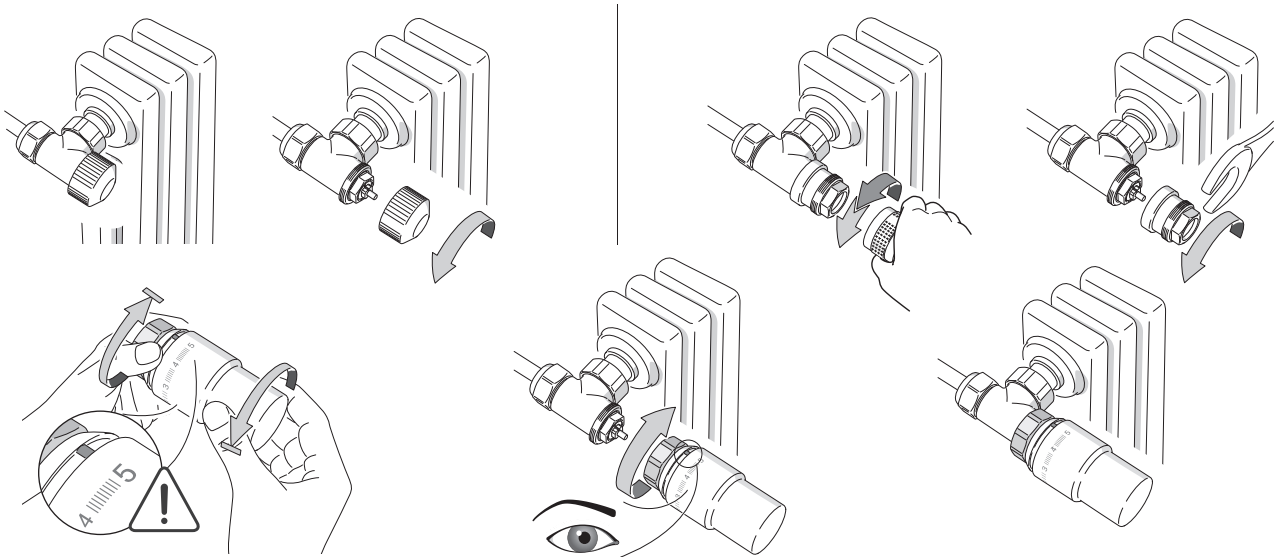

Avvertenze e consigli *Warnings and suggestions*

- Vibrazione sull'impianto - Rumori - Colpi ripetuti

POSSIBILE CAUSA: la circolazione del fluido attraversa la valvola nella direzione opposta di come indicato dalla freccia sul corpo.

SOLUZIONE: invertire il flusso ripristinando il senso corretto.

POSSIBILE CAUSA: valvole chiuse (raggiunta temperatura impostata sulla testa termostatica) e pompa attiva, mancanza di valvola di by-pass differenziale.

SOLUZIONE: installare la valvola di by-pass differenziale.

- Suono - Sibilo in fase di modulazione

POSSIBILE CAUSA: la valvola è sottoposta ad una eccessiva prevalenza.

SOLUZIONE: controllare e ridurre la pressione dell'impianto o installare valvola di bilanciamento.

- Stoccaggio

Conservare le valvole a una temperatura compresa tra -20°C e +50°C.

- Presence of vibrations in the system - Noises - repeated hits

POSSIBLE CAUSE: the fluid flows through the valve in the opposite way with respect to the correct direction indicated by the arrow on the body.

SOLUTION: resetting the correct flow direction.

POSSIBLE CAUSE: radiator valves are closed (because the temperature set on the thermostatic head is reached), the pump is on and there's no differential by-pass valve.

SOLUTION: installing a differential by-pass valve.

- Presence of sound - whistle during the modulation phase

POSSIBLE CAUSE: too much pressure on the valve with respect to the rest of the system.

SOLUTION: checking and reducing the system pressure or installing a balancing valve.

- Storage

Store the valves at a temperature between -20°C and +50°C.

0613

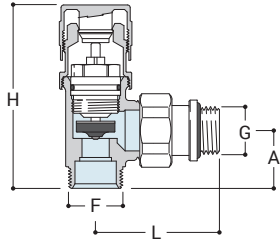

G	F	H	A	L
3/8"	24x19*	81	26	55
1/2"	24x19*	81	26	55

0633

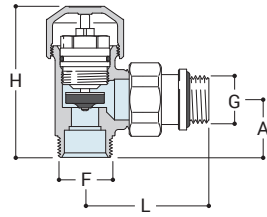

G	F	H	A	L
3/8"	24x19*	67	26	55
1/2"	24x19*	67	26	55

0615

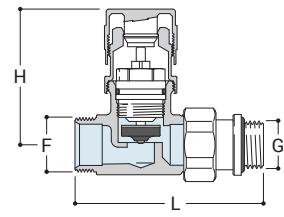

G	F	H	L
3/8"	24x19*	60	83
1/2"	24x19*	60	83

0635

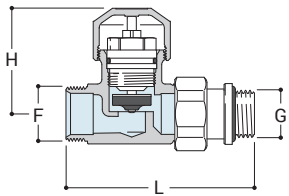

G	F	H	L
3/8"	24x19*	47	83
1/2"	24x19*	47	83

0618

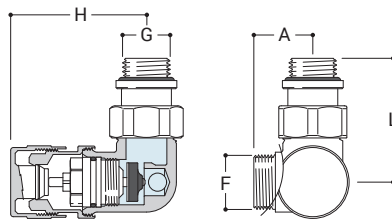

G	F	H	A	L
3/8"	24x19*	60	26	55
1/2"	24x19*	60	26	55

0478

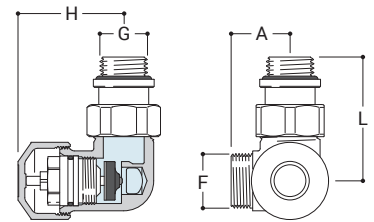

G	F	H	A	L
3/8"	24x19*	47	26	55
1/2"	24x19*	47	26	55

0619

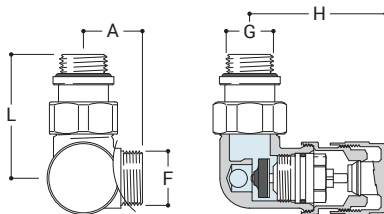

G	F	H	A	L
3/8"	24x19*	60	26	55
1/2"	24x19*	60	26	55

0479

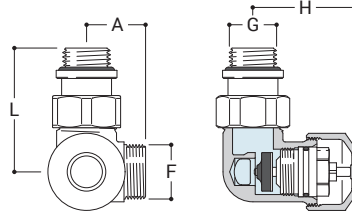

G	F	H	A	L
3/8"	24x19*	47	26	55
1/2"	24x19*	47	26	55

0614

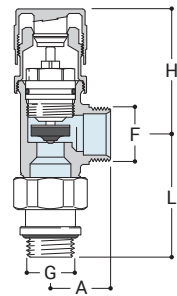

G	F	H	A	L
3/8"	24x19*	55	26	55
1/2"	24x19*	55	26	55

0634

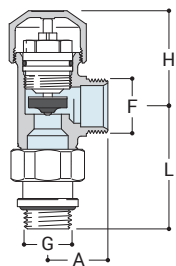

G	F	H	A	L
3/8"	24x19*	42	26	55
1/2"	24x19*	42	26	55

0636

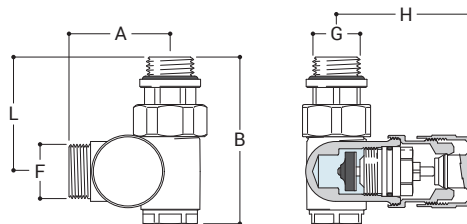

G	F	H	A	L	B
1/2"	24x19	60	45	52	73

0641

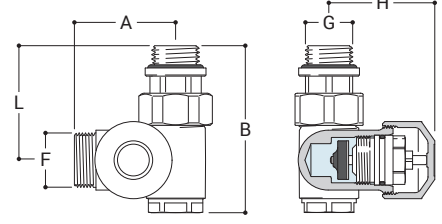

G	F	H	A	L	B
1/2"	24x19	47	45	52	73

* = 3/4" E

0637

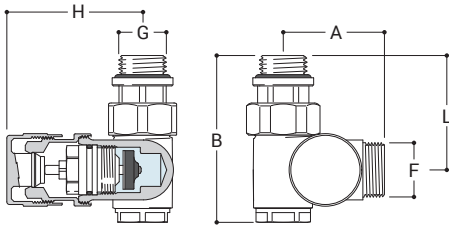

G	F	H	A	L	B
1/2"	24x19	60	45	52	73

0642

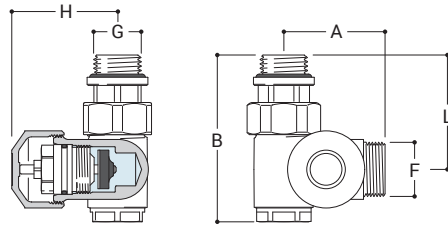

G	F	H	A	L	B
1/2"	24x19	47	45	52	73

0610

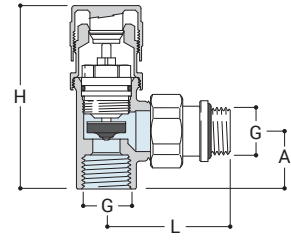

G	H	A	L
3/8"	81	26	55
1/2"	81	26	55

0640

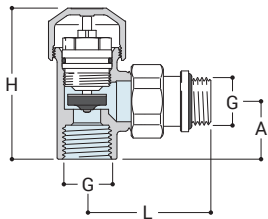

G	H	A	L
3/8"	67	26	55
1/2"	67	26	55

0612

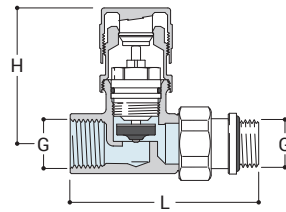

G	H	L
3/8"	60	83
1/2"	60	83

0632

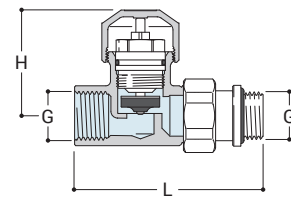

G	H	L
3/8"	47	83
1/2"	47	83

0616

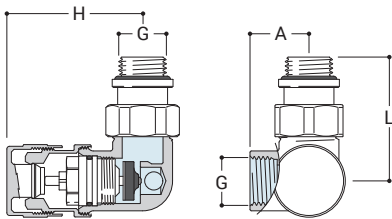

G	H	A	L
3/8"	60	26	55
1/2"	60	26	55

0469

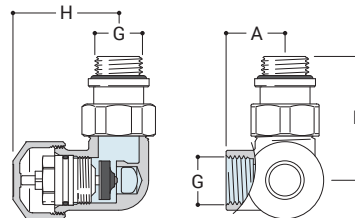

G	H	A	L
3/8"	47	26	55
1/2"	47	26	55

0611

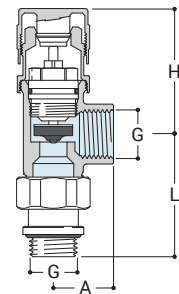

G	H	A	L
3/8"	55	26	54
1/2"	55	26	54

0617

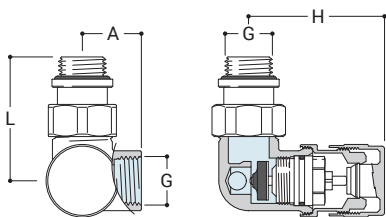

G	H	A	L
3/8"	60	26	55
1/2"	60	26	55

0477

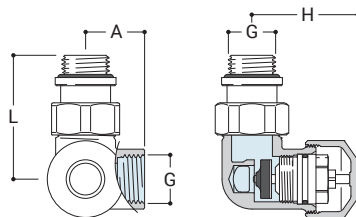

G	H	A	L
3/8"	47	26	55
1/2"	47	26	55

0631

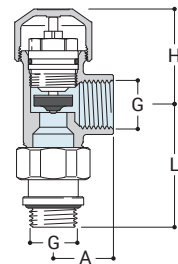

G	H	A	L
3/8"	42	26	54
1/2"	42	26	54

0661

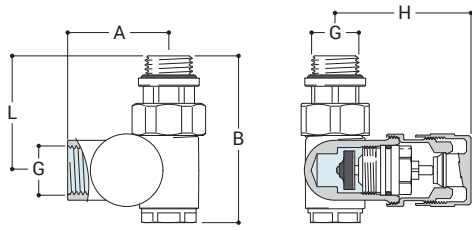

G	H	A	L	B
1/2"	60	45	52	73

0665

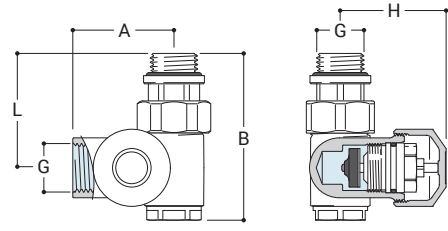

G	H	A	L	B
1/2"	47	45	52	73

0662

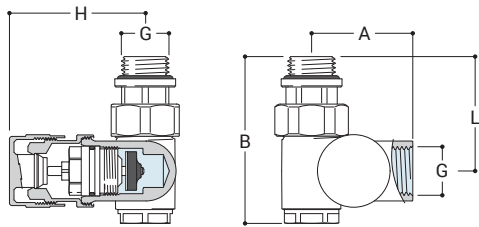

G	H	A	L	B
1/2"	60	45	52	73

0666

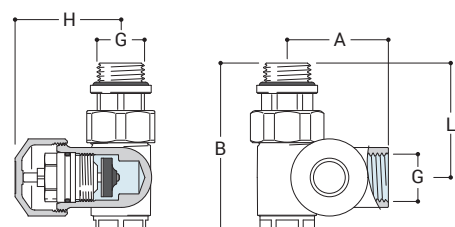

G	H	A	L	B
1/2"	47	45	52	73



0481

Raccordo per tubo rame a tenuta O-Ring.
Copper tube connection with O-ring seal.



0483

Raccordo per tubo multistrato.
Multilayer tube connection.



E481 EUROCONO

Raccordo per tubo rame a tenuta O-Ring.
Copper tube connection with O-ring seal.



E483 EUROCONO

Raccordo per tubo multistrato.
Multilayer tube connection.



0301

Adattatore 1/2" F x 24/19 F
Adaptor 1/2" F x 24/19 F.



0027

Prolunga per valvole (30 mm).
Extension for radiator valves (30 mm)



0030

Eccentrico per radiatori.
Cam for radiators.



0402

Codolo telescopico
Telescopic tailpiece



0031

Raccordo 1/2" con tubo saldato ø 15 mm.
1/2" connection with welded pipe ø 15 mm.



0490

Rosetta
Wall plate



0491

Kit copritubo tondo (2 pezzi).
Round pipe cover set (2 pcs).



A491

Kit di collegamento con rosoni tondi (2 pezzi), ø 15 mm, lunghezza 150 mm x 1/2".
Round connection set (2 pcs), ø 15 mm, length 150 mm x 1/2"



C261

Chiavetta di Regolazione per vitone termostatico.
Pre-setting key for thermostatic insert.



N093 DOMUS

Testa termostatica con sensore a liquido.
Thermostatic head with liquid sensor.



N094 ARIA

Testa termostatica con sensore a liquido.
Thermostatic head with liquid sensor.



0803

Termostato elettronico da radiatore in radiofrequenza
Radiofrequency electronic radiator controller.